

Transient Voltage Suppressors

TVS Diodes - 600W > P6KE Series



Description

The P6KE series is designed specifically to protect sensitive electronic equipment from voltage transients induced by lightning and other transient voltage events.

Features

- For surface mounted applications in order to optimize board space
- Reliable low cost construction utilizing molded plastic technique
- Plastic material has UL flammability classification 94V-O
- Typical IR less than 1uA above 12V
- Fast response time: typically less than 1.0ps from 0 Volts to VBR min
- Glass passivated junction
- Low inductance
- High Temperature soldering: 260°C/10 seconds at terminals

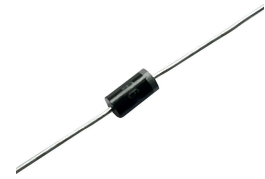

Package: DO-204AC / DO-15

Applications

- I/O interface
- AC/DC power supply
- Low frequency signal transmission line (RS232, RS485, etc.)

Electrical Characteristics

Parameter	Symbol	Value	Unit
Peak Pulse Power Dissipation at TA=25°C by 10x1000µs waveform (Fig.1)(Note 1), (Note 2)	PPPM	600	W
Power Dissipation on infinite heat sink at TA=50°C	PM(AV)	5	W
Peak Forward Surge Current, 8.3ms Single Half Sine Wave (Note 3)	IFSM	100	A
Maximum Instantaneous Forward Voltage at 25A for Unidirectional only (Note 4)	VF	3.5/5	V
Operating Junction and Storage Temperature Range	Tj, TSTG	-65 to 150	°C
Typical Thermal Resistance Junction to Lead	RθJL	20	°C/W
Typical Thermal Resistance Junction to Ambient	RθJA	75	°C/W

Notes:

1. Non-repetitive current pulse, per Fig.3 and derated above TA=25°C per Fig. 2.
2. Measured on 8.3ms single half sine wave or equivalent square wave for unidirectional device only.
3. $V_F < 3.5V$ for $V_{BR} \leq 200V$ and $V_F < 6.5V$ for $V_{BR} \geq 201V$.

Electrical Characteristics (TA=25°C)

Part Number		Reverse Stand-Off Voltage	Breakdown Voltage V _{BR} (Volts)@I _T		Test Current	Maximum Clamping Voltage @I _{PP}	Peak Pulse Current	Reverse Leakage @V _{RWM}
Unidirectional	Bidirectional	V _{RWM} (V)	Min	Max	I _T (mA)	V _C (V)	I _{PP} (A)	I _R (μA)
P6KE6.8A	P6KE6.8CA	5.80	6.45	7.14	10	10.5	58.1	1000
P6KE7.5A	P6KE7.5CA	6.40	7.13	7.88	10	11.3	54.0	500
P6KE8.2A	P6KE8.2CA	7.02	7.79	8.61	10	12.1	50.4	200
P6KE9.1A	P6KE9.1CA	7.78	8.65	9.55	1	13.4	45.5	50
P6KE10A	P6KE10CA	8.55	9.50	10.5	1	14.5	42.1	10
P6KE11A	P6KE11CA	9.40	10.5	11.6	1	15.6	39.1	5
P6KE12A	P6KE12CA	10.2	11.4	12.6	1	16.7	36.5	5
P6KE13A	P6KE13CA	11.1	12.4	13.7	1	18.2	33.5	5
P6KE15A	P6KE15CA	12.8	14.3	15.8	1	21.2	28.8	5
P6KE16A	P6KE16CA	13.6	15.2	16.8	1	22.5	27.1	5
P6KE18A	P6KE18CA	15.3	17.1	18.9	1	25.2	24.2	5
P6KE20A	P6KE20CA	17.1	19.0	21.0	1	27.7	22.0	5
P6KE22A	P6KE22CA	18.8	20.9	23.1	1	30.6	19.9	5
P6KE24A	P6KE24CA	20.5	22.8	25.2	1	33.2	18.4	5
P6KE27A	P6KE27CA	23.1	25.7	28.4	1	37.5	16.3	5
P6KE30A	P6KE30CA	25.6	28.5	31.5	1	41.4	14.7	5
P6KE33A	P6KE33CA	28.2	31.4	34.7	1	45.7	13.3	5
P6KE36A	P6KE36CA	30.8	34.2	37.8	1	49.9	12.2	5
P6KE39A	P6KE39CA	33.3	37.1	41.0	1	53.9	11.3	5
P6KE43A	P6KE43CA	36.8	40.9	45.2	1	59.3	10.3	5
P6KE47A	P6KE47CA	40.2	44.7	49.4	1	64.8	9.4	5
P6KE51A	P6KE51CA	43.6	48.5	53.6	1	70.1	8.7	5
P6KE56A	P6KE56CA	47.8	53.2	58.8	1	77.0	7.9	5
P6KE62A	P6KE62CA	53.0	58.9	65.1	1	85.0	7.2	5

Electrical Characteristics (TA=25°C)

continued

Part Number		Reverse Stand-Off Voltage	Breakdown Voltage V _{BR} (Volts)@I _T		Test Current	Maximum Clamping Voltage @I _{PP}	Peak Pulse Current	Reverse Leakage @V _{RWM}
Unidirectional	Bidirectional	V _{RWM} (V)	Min	Max	I _T (mA)	V _C (V)	I _{PP} (A)	I _R (μA)
P6KE68A	P6KE68CA	58.1	64.6	71.4	1	92.0	6.6	5
P6KE75A	P6KE75CA	64.1	71.3	78.8	1	103.0	5.9	5
P6KE82A	P6KE82CA	70.1	77.9	86.1	1	113.0	5.4	5
P6KE91A	P6KE91CA	77.8	86.5	95.5	1	125.0	4.9	5
P6KE100A	P6KE100CA	85.5	95.0	105.0	1	137.0	4.5	5
P6KE110A	P6KE110CA	94.0	105.0	116.0	1	152.0	4.0	5
P6KE120A	P6KE120CA	102.0	114.0	126.0	1	165.0	3.7	5
P6KE130A	P6KE130CA	111.0	124.0	137.0	1	179.0	3.4	5
P6KE150A	P6KE150CA	128.0	143.0	158.0	1	207.0	2.9	5
P6KE160A	P6KE160CA	136.0	152.0	168.0	1	219.0	2.8	5
P6KE170A	P6KE170CA	145.0	162.0	179.0	1	234.0	2.6	5
P6KE180A	P6KE180CA	154.0	171.0	189.0	1	246.0	2.5	5
P6KE200A	P6KE200CA	171.0	190.0	210.0	1	274.0	2.2	5
P6KE220A	P6KE220CA	185.0	209.0	231.0	1	328.0	1.9	5
P6KE250A	P6KE250CA	214.0	237.0	263.0	1	344.0	1.8	5
P6KE300A	P6KE300CA	256.0	285.0	315.0	1	414.0	1.5	5
P6KE350A	P6KE350CA	300.0	332.0	368.0	1	482.0	1.3	5
P6KE400A	P6KE400CA	342.0	380.0	420.0	1	548.0	1.1	5
P6KE440A	P6KE440CA	376.0	418.0	462.0	1	602.0	1.0	5
P6KE480A	P6KE480CA	408.0	456.0	504.0	1	658.0	0.9	5
P6KE510A	P6KE510CA	434.0	485.0	535.0	1	698.0	0.9	5
P6KE540A	P6KE540CA	486.0	513.0	567.0	1	740.0	0.8	5
P6KE550A	P6KE550CA	495.0	522.5	577.5	1	760.0	0.8	5
P6KE600A	P6KE600CA	512.0	570.0	630.0	1	828.0	0.75	5

Notes: For bidirectional type having V_{RWM} of 10 volts and less, the I_R limit is double.

Description of Part Number

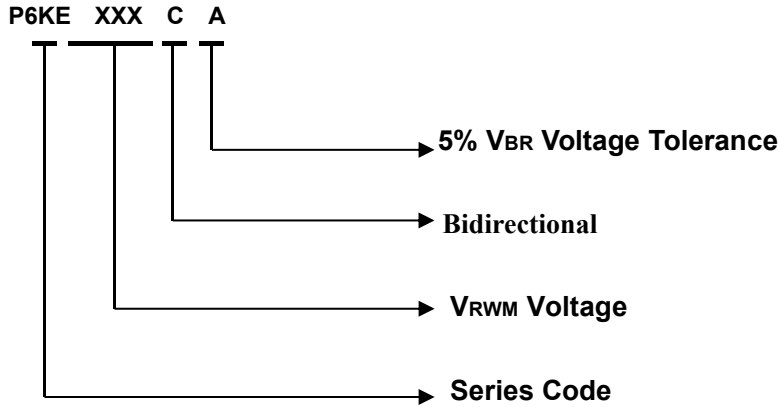

Packing Options

Package Type	Description	Packing Quantity	Industry Standard
DO-15 	Tape and Reel Pack	2000 PCS	EIA STD RS-296E

Dimensions - DO-204AC / DO-15

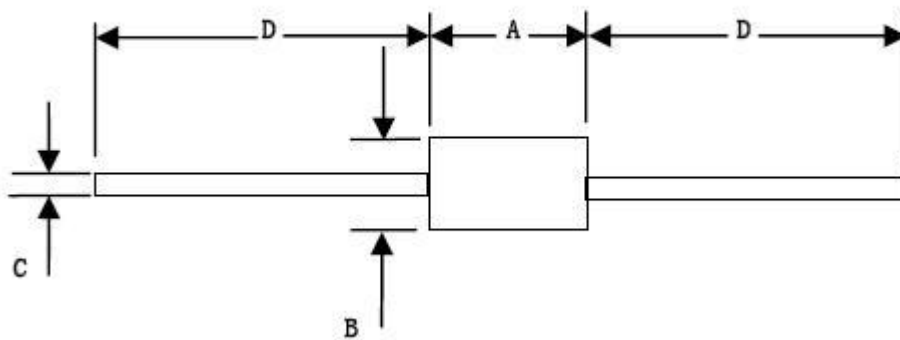

Dimension	Inches		Millimeters		Note
	Min	Max	Min	Max	
A	0.230	0.300	5.80	7.60	
B	0.104	0.140	2.60	3.60	Φ
C	0.026	0.034	0.70	0.90	Φ
D	1.000		25.4		

Ratings and Characteristics Curve

Figure 1. Peak Pulse Power Rating Curve

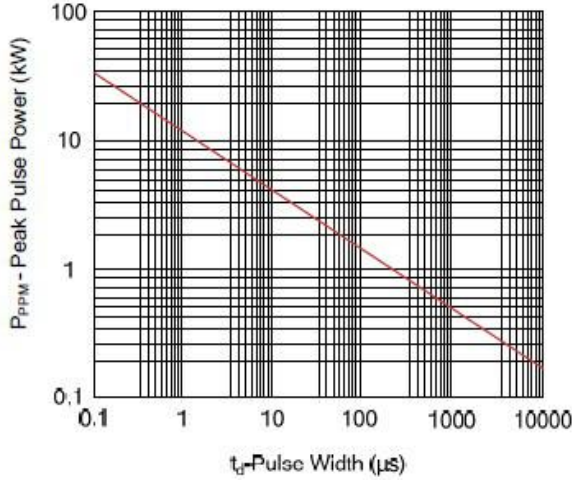

Figure 2. Pulse Derating Curve

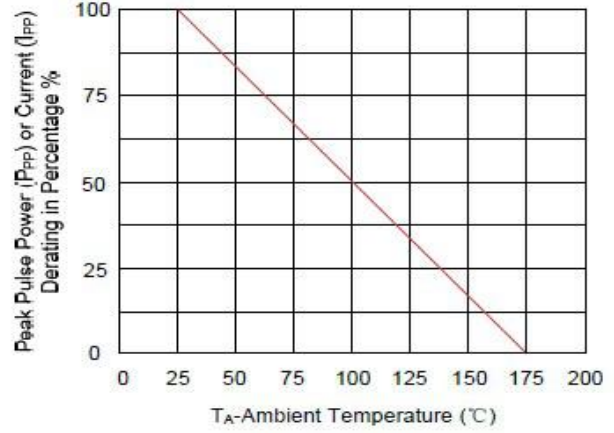

Figure 3. Pulse Waveform

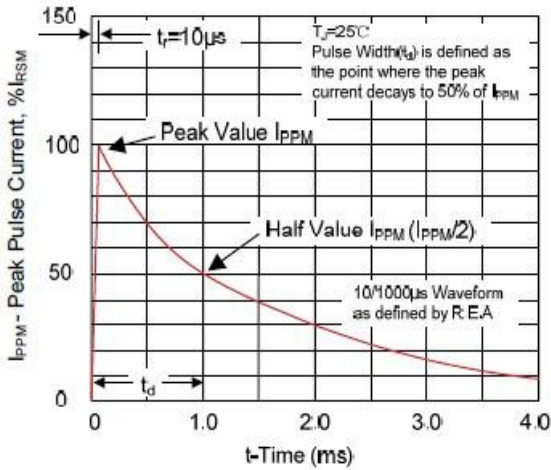

Figure 4. Typical Junction Capacitance

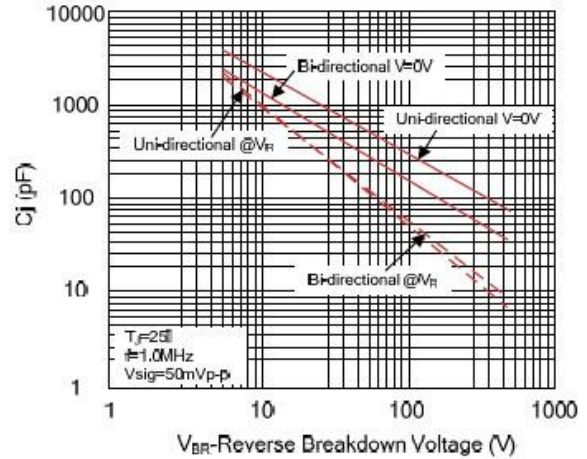

Figure 5. Steady State Power Dissipation Derating Curve

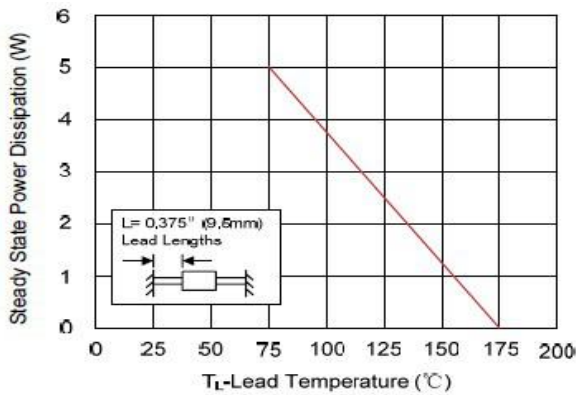
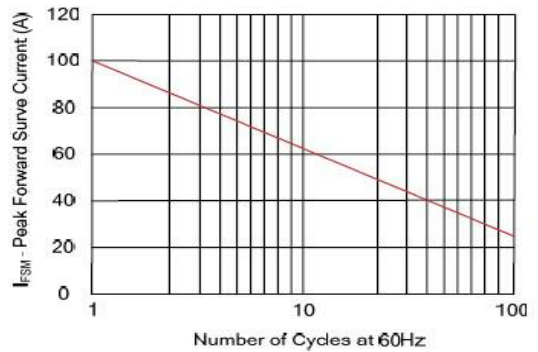

Figure 6. Maximum Non-Repetitive Forward Surge Current Uni-Directional Only



sales@huaandz.com