

## Transient Voltage Suppressors

TVS Diodes - 1500W > 1.5KE Series



### Description

The 1.5KE series is designed specifically to protect sensitive electronic equipment from voltage transients induced by lightning and other transient voltage events.

### Features

- Plastic material has UL flammability classification 94V-0
- Typical IR less than 1uA above 12V
- Fast response time
- Glass passivated junction
- Low zener impedance • Excellent clamping capability
- Low inductance
- High Temperature soldering: 260°C/10 seconds at terminals



Package: DO-201

### Applications

- I/O interface
- AC/DC power supply
- Low frequency signal transmission line (RS232, RS485, etc.)

### Electrical Characteristics

Parameter	Symbol	Value	Unit
Peak Pulse Power Dissipation at TA=25°C by 10 / 1000µs waveform (Fig.1)(Note 1)	PPPM	1500	W
Steady state power dissipation at TL=75°C (Fig.5)	PM(AV)	6.5	W
Peak Forward Surge Current, 8.3ms Single Half Sine Wave superimposed on rated load, (JEDEC Method) (Note2, Fig.6)	IFSM	200	A
Operating Junction and Storage Temperature Range	Tj, TSTG	-55 to 175	°C
Typical Thermal Resistance Junction to Lead	RθJL	15	°C/W
Typical Thermal Resistance Junction to Ambient	RθJA	75	°C/W

#### Notes:

1. Non-repetitive current pulse, per Fig.3 and derated above TA=25°C per Fig. 2.
2. 8.3ms single half sine-wave, or equivalent square wave, duty cycle=4 pulses per minutes maximum.

Electrical Characteristics (TA=25°C)

Part Number		Reverse Stand-Off Voltage	Breakdown Voltage V <sub>BR</sub> (Volts)@I <sub>T</sub>		Test Current	Maximum Clamping Voltage @I <sub>PP</sub>	Peak Pulse Current	Reverse Leakage @V <sub>RWM</sub>
Unidirectional	Bidirectional	V <sub>RWM</sub> (V)	Min	Max	I <sub>T</sub> (mA)	V <sub>C</sub> (V)	I <sub>PP</sub> (A)	I <sub>R</sub> (μA)
1.5KE6.8A	1.5KE6.8CA	5.80	6.45	7.14	10	10.5	144.8	1000
1.5KE7.5A	1.5KE7.5CA	6.40	7.13	7.88	10	11.3	134.5	500
1.5KE8.2A	1.5KE8.2CA	7.02	7.79	8.61	10	12.1	125.6	200
1.5KE9.1A	1.5KE9.1CA	7.78	8.65	9.5	1	13.4	113.4	50
1.5KE10A	1.5KE10CA	8.55	9.5	10.5	1	14.5	104.8	10
1.5KE11A	1.5KE11CA	9.40	10.5	11.6	1	15.6	97.4	5
1.5KE12A	1.5KE12CA	10.20	11.4	12.6	1	16.7	91	5
1.5KE13A	1.5KE13CA	11.1	12.4	13.7	1	18.2	83.5	1
1.5KE15A	1.5KE15CA	12.8	14.3	15.8	1	21.2	71	1
1.5KE16A	1.5KE16CA	13.6	15.2	16.8	1	22.5	67.6	1
1.5KE18A	1.5KE18CA	15.3	17.1	18.9	1	25.2	60.3	1
1.5KE20A	1.5KE20CA	17.1	19	21	1	27.7	54.9	1
1.5KE22A	1.5KE22CA	18.8	20.9	23.1	1	30.6	49.7	1
1.5KE24A	1.5KE24CA	20.5	22.8	25.2	1	33.2	45.8	1
1.5KE27A	1.5KE27CA	23.1	25.7	28.4	1	37.5	40.5	1
1.5KE30A	1.5KE30CA	25.6	28.5	31.5	1	41.4	36.7	1
1.5KE33A	1.5KE33CA	28.2	31.4	34.7	1	45.7	33.3	1
1.5KE36A	1.5KE36CA	30.8	34.2	37.8	1	49.9	30.5	1
1.5KE39A	1.5KE39CA	33.3	37.1	41	1	53.9	28.2	1
1.5KE43A	1.5KE43CA	36.8	40.9	45.2	1	59.3	25.6	1
1.5KE47A	1.5KE47CA	40.2	44.7	49.4	1	64.8	23.5	1
1.5KE51A	1.5KE51CA	43.6	48.5	53.6	1	70.1	21.7	1
1.5KE56A	1.5KE56CA	47.8	53.2	58.8	1	77	19.7	1
1.5KE62A	1.5KE62CA	53	58.9	65.1	1	85	17.9	1

Electrical Characteristics (TA=25°C)

continued

Part Number		Reverse Stand-Off Voltage	Breakdown Voltage V <sub>BR</sub> (Volts)@I <sub>T</sub>		Test Current	Maximum Clamping Voltage @I <sub>PP</sub>	Peak Pulse Current	Reverse Leakage @V <sub>RWM</sub>
Unidirectional	Bidirectional	V <sub>RWM</sub> (V)	Min	Max	I <sub>T</sub> (mA)	V <sub>C</sub> (V)	I <sub>PP</sub> (A)	I <sub>R</sub> (μA)
1.5KE68A	1.5KE68CA	58.1	64.6	71.4	1	92	16.5	1
1.5KE75A	1.5KE75CA	64.1	71.3	78.8	1	103	14.8	1
1.5KE82A	1.5KE82CA	70.1	77.9	86.1	1	113	13.5	1
1.5KE91A	1.5KE91CA	77.8	86.5	95.5	1	125	12.2	1
1.5KE100A	1.5KE100CA	85.5	95	105	1	137	11.1	1
1.5KE110A	1.5KE110CA	94	105	116	1	152	10	1
1.5KE120A	1.5KE120CA	102	114	126	1	165	9.2	1
1.5KE130A	1.5KE130CA	111	124	137	1	179	8.5	1
1.5KE150A	1.5KE150CA	128	143	158	1	207	7.3	1
1.5KE160A	1.5KE160CA	136	152	168	1	219	6.9	1
1.5KE170A	1.5KE170CA	145	162	179	1	234	6.5	1
1.5KE180A	1.5KE180CA	154	171	189	1	246	6.2	1
1.5KE200A	1.5KE200CA	171	190	210	1	274	5.5	1
1.5KE220A	1.5KE220CA	185	209	231	1	328	4.6	1
1.5KE250A	1.5KE250CA	214	237	263	1	344	4.4	1
1.5KE300A	1.5KE300CA	256	285	315	1	414	3.7	1
1.5KE350A	1.5KE350CA	300	332	368	1	482	3.2	1
1.5KE400A	1.5KE400CA	342	380	420	1	548	2.8	1
1.5KE440A	1.5KE440CA	376	418	462	1	602	2.5	1
1.5KE480A	1.5KE480CA	408	456	504	1	658	2.3	1
1.5KE510A	1.5KE510CA	434	485	535	1	698	2.1	1
1.5KE530A	1.5KE530CA	450	503.5	556.5	1	725	2.1	1
1.5KE540A	1.5KE540CA	459	513	567	1	740	2	1
1.5KE550A	1.5KE550CA	467	522.5	577.5	1	760	2	1

Notes: For bidirectional type having V<sub>RWM</sub> of 10 volts and less, the I<sub>R</sub> limit is double.

## Description of Part Number

1.5KE XXX C A

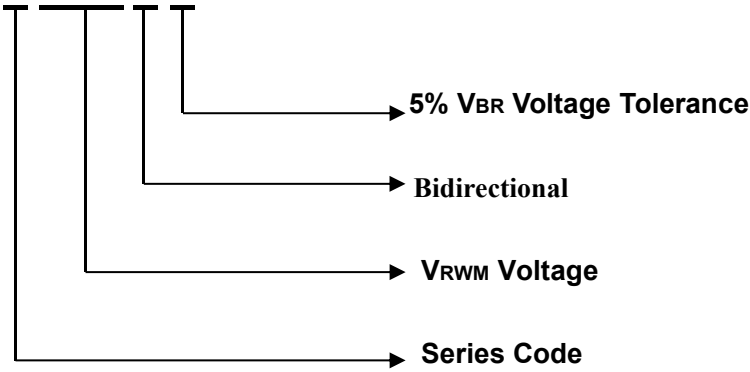

## Packing Options

Package Type	Description	Packing Quantity	Industry Standard
 DO-201	Tape and Reel Pack	1000PCS	EIA STD RS-296

## Dimensions - DO-201

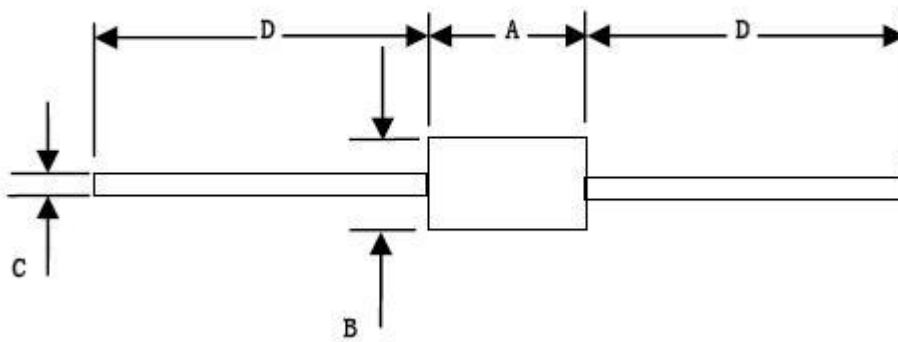

Dimension	Inches		Millimeters	
	Min	Max	Min	Max
A	0.285	0.375	7.20	9.50
B	0.190	0.210	4.80	5.30
C	0.038	0.042	0.96	1.07
D	1.000		25.4	

## Ratings and Characteristics Curve

Figure 1. Peak Pulse Power Rating Curve

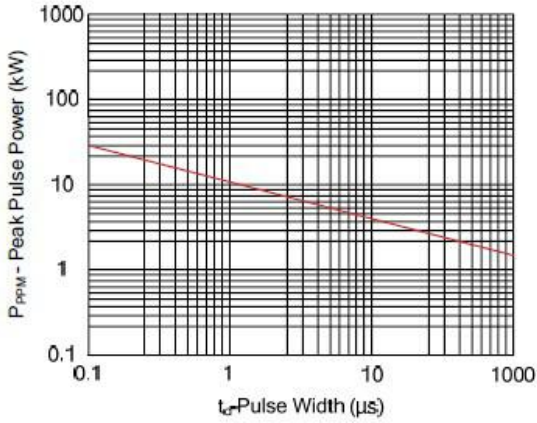

Figure 2. Pulse Derating Curve

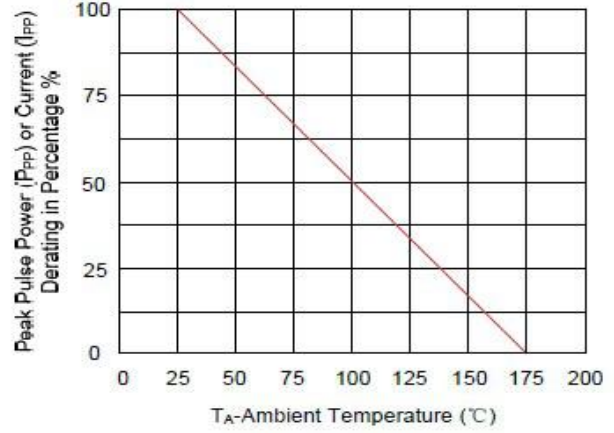

Figure 3. Pulse Waveform

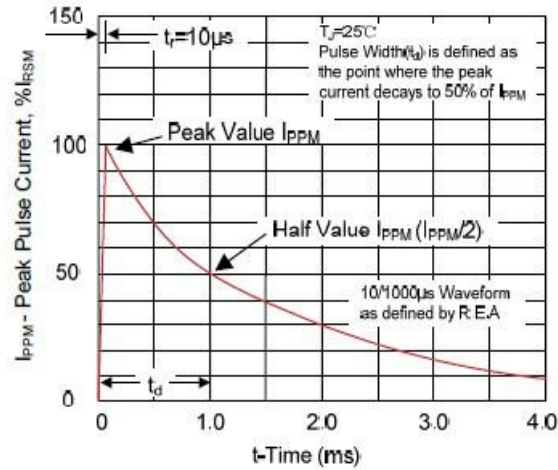

Figure 4. Typical Junction Capacitance

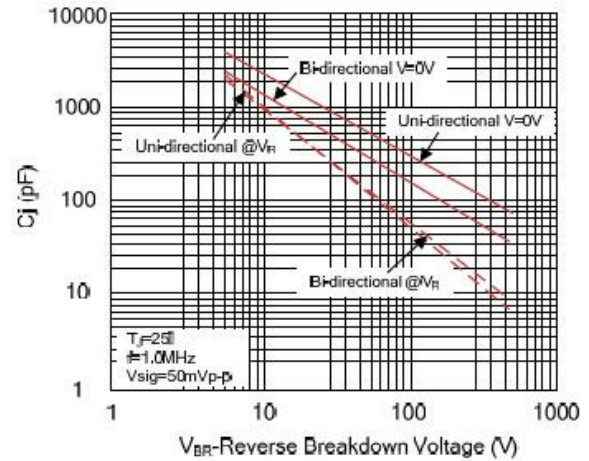

Figure 5. Steady State Power Dissipation Derating Curve

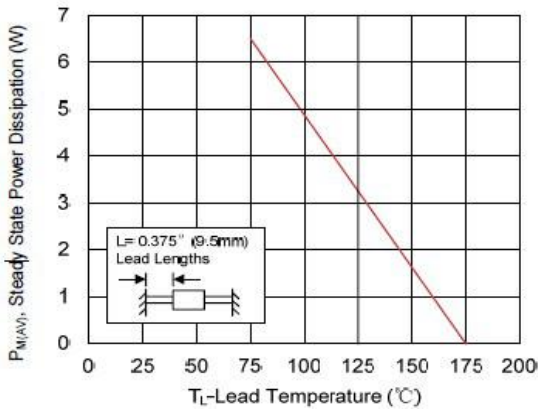
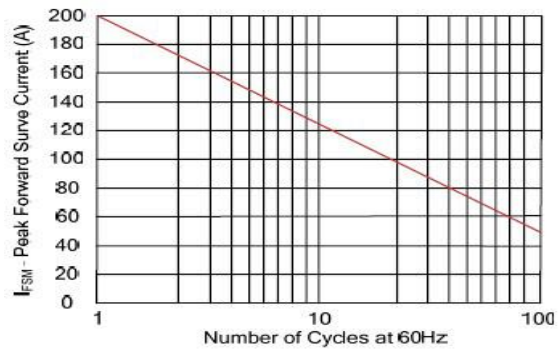

Figure 6. Maximum Non-Repetitive Forward Surge Current Uni-Directional Only



[sales@huaandz.com](mailto:sales@huaandz.com)